

Sales Code: BU131AS36D

Description: Butler Sink Sw & Of 895X550x220

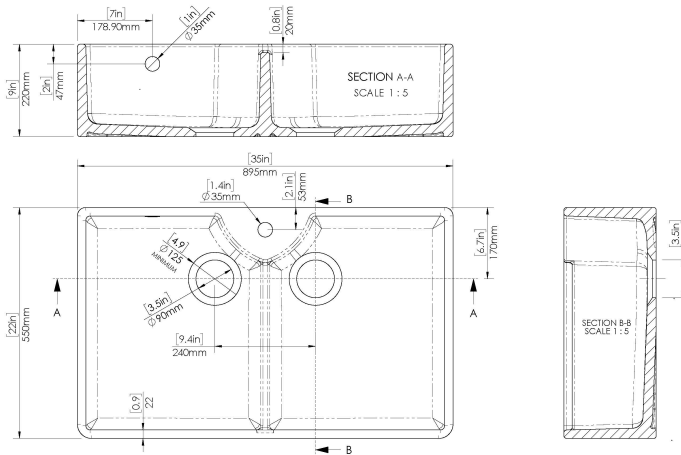
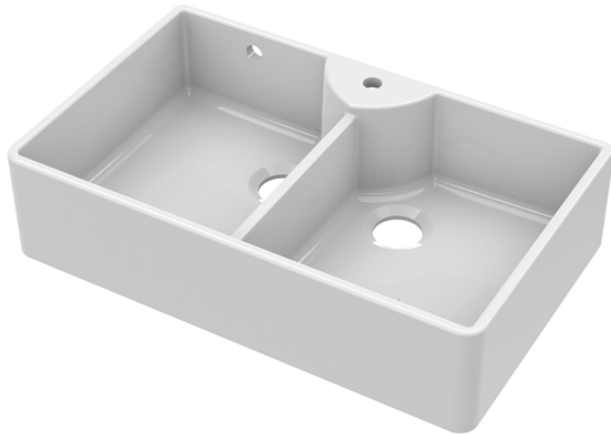

Product Dimensions

Height (mm):	220
Width (mm):	895
Depth (mm):	550
Nett Weight (kg):	52.5

Packaging Dimensions

Height (mm):	237
Width (mm):	914
Depth (mm):	557
Gross Weight (kg):	53

Packaging Data

Box Colour:	Brown Cardboard Box
Box Qty:	1
Label Size:	100 x 50
Label Colour:	White Label
Label Qty:	2

Outer Box Dimensions (If Applicable)

Height (mm):	
Width (mm):	
Depth (mm):	
Gross Weight (kg):	
Barcode:	5055275868584

Product Details

Country of Origin:	Utd.Arab.Emir.	
Fitting Instruction:	No	
Certification: CE & UKCA:	WRAS:	WRAS No:
Product Material:		
Fixing Supplied:		

Pans/Bidets: Trap Style: _____ Includes Seat: _____

Seats: Seat Type: _____ Material: _____
 Function: _____ Hinge Type: _____
 Hinge Material: _____

Cisterns: Operating Type: _____ Fittings: _____
 Lever Type: _____

Basins: Tap Hole: _____ Chain Stay Hole: _____
 Template: _____ Waste Type Req: _____
 Overflow Inc: _____ Overflow Cover: _____
 Inner Bowl Depth (mm): 198