

Sales Code: H032

Description: Knurled Bar Handle 192mm Centres

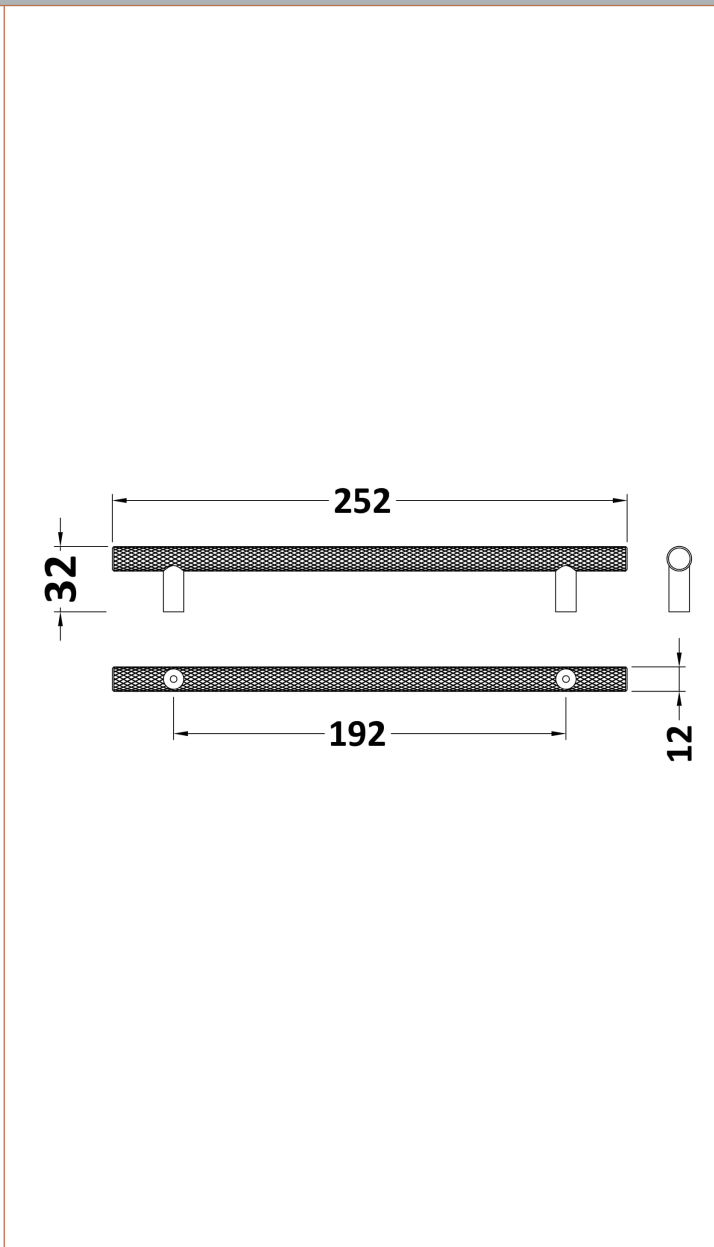

Product Dimensions

Length (mm):	
Width (mm):	16
Height (mm):	155
Depth (mm):	36
Nett Weight (kg):	0.08

Packaging Dimensions

Height (mm):	220
Width (mm):	1
Depth (mm):	1
Gross Weight (kg):	0.08

Packaging Data

Box Colour:	Polybagged
Box Qty:	1
Label Size:	100 x 50
Label Colour:	White Label
Label Qty:	1

Outer Box Dimensions (If Applicable)

Height (mm):	
Width (mm):	
Length (mm):	
Depth (mm):	
Gross Weight (kg):	
Barcode:	5056211899136

Product Details

Country of Origin:	China
Fitting Instruction:	No
CE & UKCA:	N/A
Product Material:	Brass
Heating Element Wattage:	Not Applicable
Colour/Finish:	
Product Diameter:	16 mm
Connection Size:	192mm Centres