

Sales Code: HLA37D

Description: Revive Horizontal Double Panel 600X412

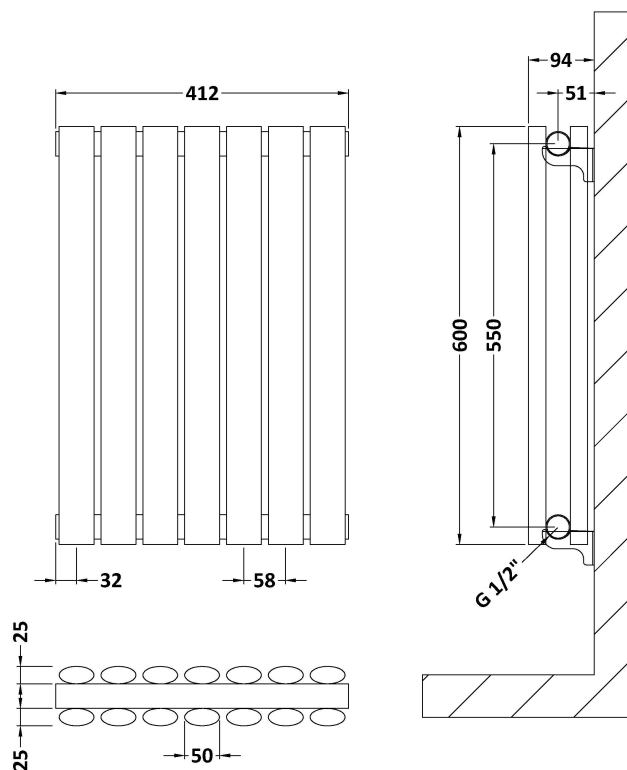

Product Dimensions

Height (mm):	600
Width (mm):	412
Depth (mm):	78
Length (mm):	
Nett Weight (kg):	16.3

Packaging Dimensions

Height (mm):	105
Width (mm):	470
Length (mm):	665
Gross Weight (kg):	16.8

Packaging Data

Box Colour:	White Cardboard Shrinkwrapped
Box Qty:	1
Label Size:	100 x 50
Label Colour:	White Label
Label Qty:	2

Outer Box Dimensions (If Applicable)

Height (mm):	
Width (mm):	
Length (mm):	
Gross Weight (kg):	
Barcode:	5056211885184

Product Details

Country of Origin:	China		
Fitting Instruction:	No		
Certification:	CE & UKCA: Yes	RoHS: N/A	WEEE: N/A
Colour/Finish:	Anthracite		
RAL No:	7016		
Product Material:	Steel		
Heat Element Wattage:	Not Applicable		
Heating Element Wattage Compatible:	N/A		
BTU Outputs:	30°C / 800	50°C / 1546	60°C / 1958
Thermal Outputs: (Watts)	30°C / 235	50°C / 453	60°C / 574
Pipe Centres - If Vertical:			
Pipe Centres - If Horizontal:	502		
Max Projection:	110mm		
Tube Diameter:			
Packaging Volume (L):			
Wall to Centre of Tappings:	N/A		
Floor to Centre of Tappings:	51		
Dual Fuel:	N/A		
IP Rating:			