

Sales Code: HLA55

Description: Sloane Horizontal Single Panel 600X586

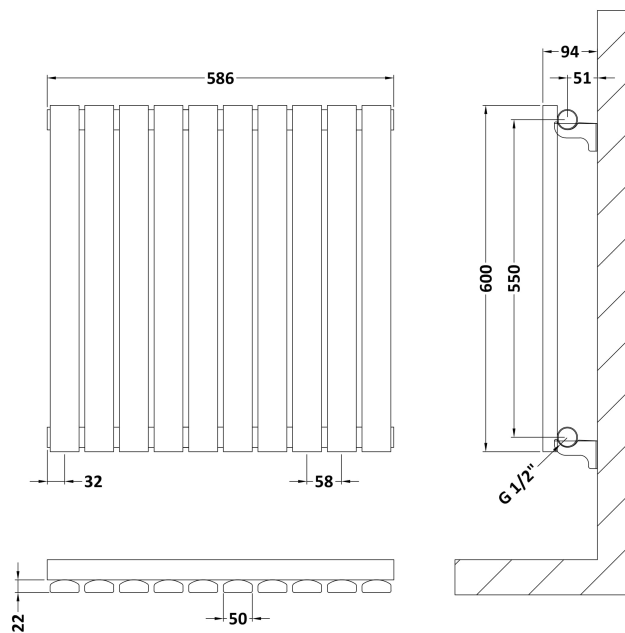
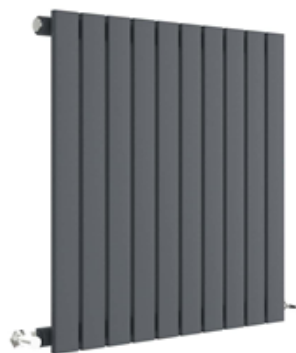

Product Dimensions

Height (mm):	600
Width (mm):	586
Depth (mm):	53
Length (mm):	
Nett Weight (kg):	11.5

Packaging Dimensions

Height (mm):	660
Width (mm):	650
Length (mm):	90
Gross Weight (kg):	12

Packaging Data

Box Colour:	White Cardboard Shrinkwrapped
Box Qty:	1
Label Size:	100 x 50
Label Colour:	White Label
Label Qty:	2

Outer Box Dimensions (If Applicable)

Height (mm):	
Width (mm):	
Length (mm):	
Gross Weight (kg):	
Barcode:	5056211885344

Product Details

Country of Origin:	China
Fitting Instruction:	No
Certification:	CE: Yes RoHS: N/A WEEE: N/A
Colour/Finish:	Anthracite
RAL No:	7016
Product Material:	Steel
Heat Element Wattage:	Not Applicable
Heating Element Wattage Compatible:	N/A
BTU Outputs:	30°C / 701 50°C / 1361 60°C / 1723
Thermal Outputs: (Watts)	30°C / 205 50°C / 399 60°C / 505
Pipe Centres - If Vertical:	
Pipe Centres - If Horizontal:	676
Max Projection:	110mm
Tube Diameter:	
Packaging Volume (L):	
Wall to Centre of Tappings:	N/A
Floor to Centre of Tappings:	51
Dual Fuel:	N/A
IP Rating:	