

Sales Code: NBV459

Description: Vessel 615 X 360 X 155

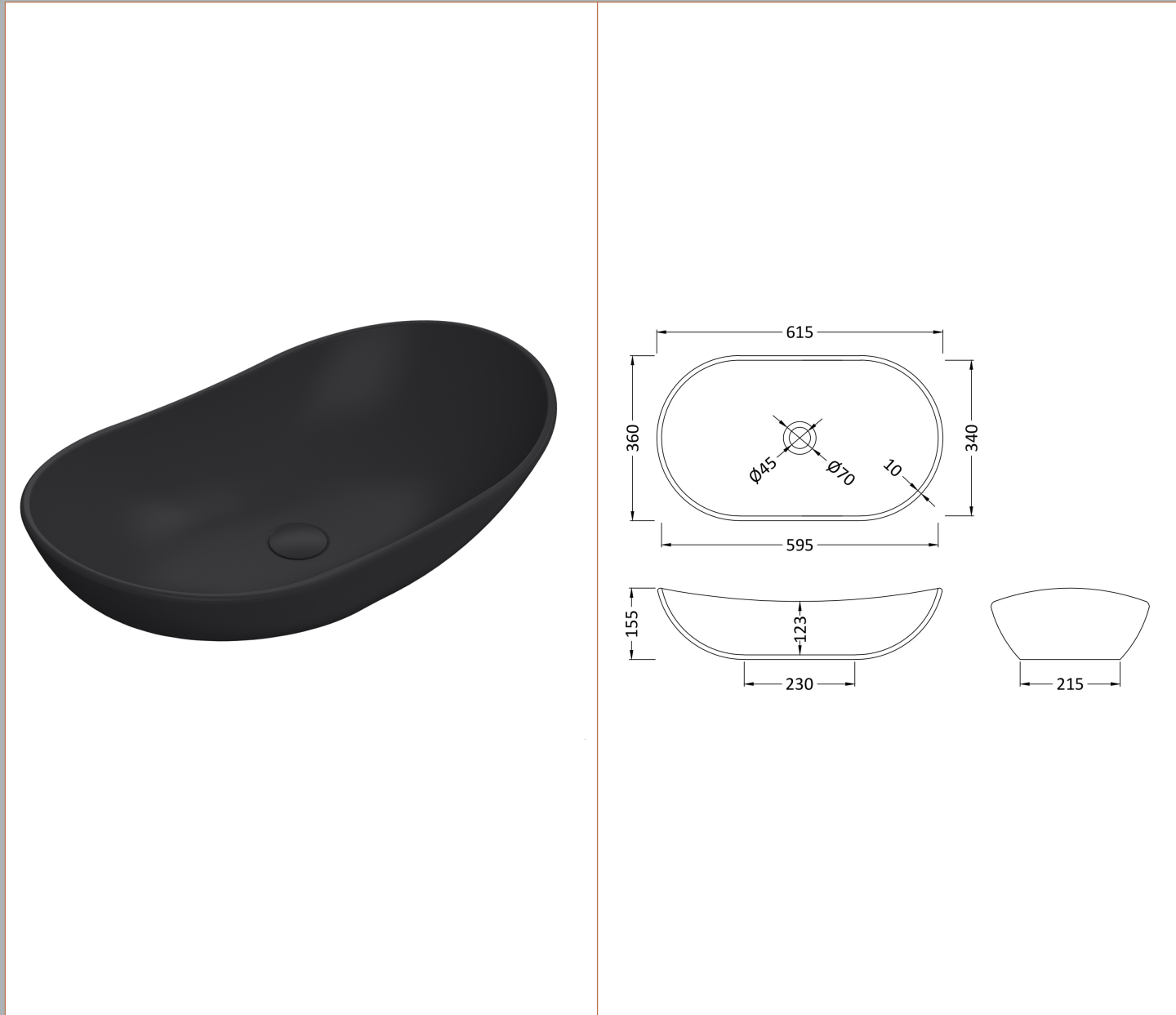

**Product Dimensions**

Height (mm):	155
Width (mm):	615
Depth (mm):	360
Nett Weight (kg):	8.7

**Packaging Dimensions**

Height (mm):	175
Width (mm):	380
Depth (mm):	630
Gross Weight (kg):	9.6

**Packaging Data**

Box Colour:	Brown Cardboard Box
Box Qty:	1
Label Size:	100 x 50
Label Colour:	White Label
Label Qty:	2

**Outer Box Dimensions (If Applicable)**

Height (mm):	
Width (mm):	
Depth (mm):	
Gross Weight (kg):	
Barcode:	5056462625164

**Product Details**

Country of Origin:	China
Fitting Instruction:	No
Certification:	CE: WRAS: WRAS No:
Product Material:	Vitreous China
Fixing Supplied:	Not Applicable

**Pans/Bidets:** Trap Style: Not Applicable Includes Seat: Not Applicable

**Seats:** Seat Type: Not Applicable Material: Not Applicable  
Function: Not Applicable Hinge Type: Not Applicable  
Hinge Material: Not Applicable

**Cisterns:** Operating Type: Not Applicable Fittings: Not Applicable  
Lever Type: Not Applicable

**Basins:** Tap Hole: No Tapholes Chain Stay Hole: No  
Template: Not Required Waste Type Req: Not Applicable  
Overflow Inc: No Overflow Cover: No  
Inner Bowl Depth (mm): 123mm