

Sales Code: NLT61023

Description: Rectangular Shower Tray 1200X800

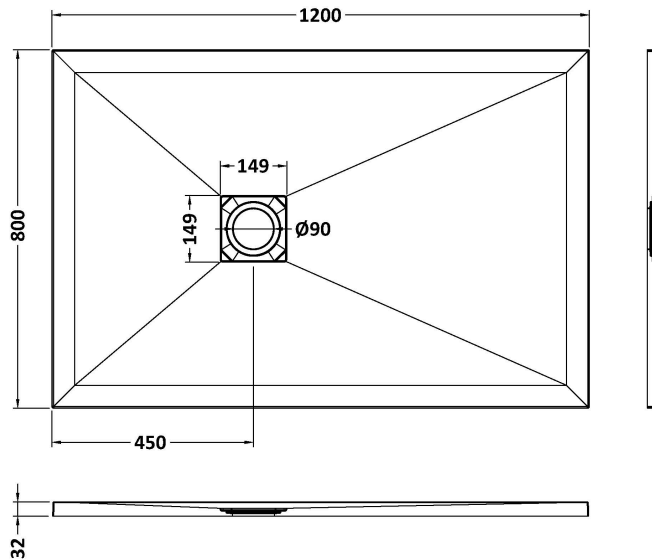

Product Dimensions

| | |
|-------------------|------|
| Length (mm): | 1200 |
| Width (mm): | 800 |
| Height (mm): | 32 |
| Nett Weight (kg): | 41.4 |

Packaging Dimensions

| | |
|--------------------|------|
| Length (mm): | 1240 |
| Width (mm): | 840 |
| Height (mm): | 73 |
| Gross Weight (kg): | 41.7 |

Packaging Data

| | |
|---------------|--------------------------|
| Box Colour: | Shrinkwrap & Polystyrene |
| Box Qty: | 1 |
| Label Size: | 100 x 50 |
| Label Colour: | White Label |
| Label Qty: | 2 |

Outer Box Dimensions (If Applicable)

| | |
|--------------------|---------------|
| Length (mm): | |
| Width (mm): | |
| Height (mm): | |
| Gross Weight (kg): | |
| Barcode: | 5056462656243 |

Product Details

| | |
|----------------------------|-------------------------------|
| Country of Origin: | United Kingdom |
| Fitting Instruction: | No |
| CE & UKCA: | Yes |
| Colour/Finish: | Slate White |
| Product Material: | Acrylic Capped ABS Caco3 & Pu |
| Material Colour Reference: | Slate White |
| Radius: | 0 |
| Waste Required (mm): | 90 |
| Compatible with Leg Kit: | No |